

COMPUTER INSTRUCTIONS

COMPUTER INSTRUCTIONS

MODEL NUMBER: LED 18

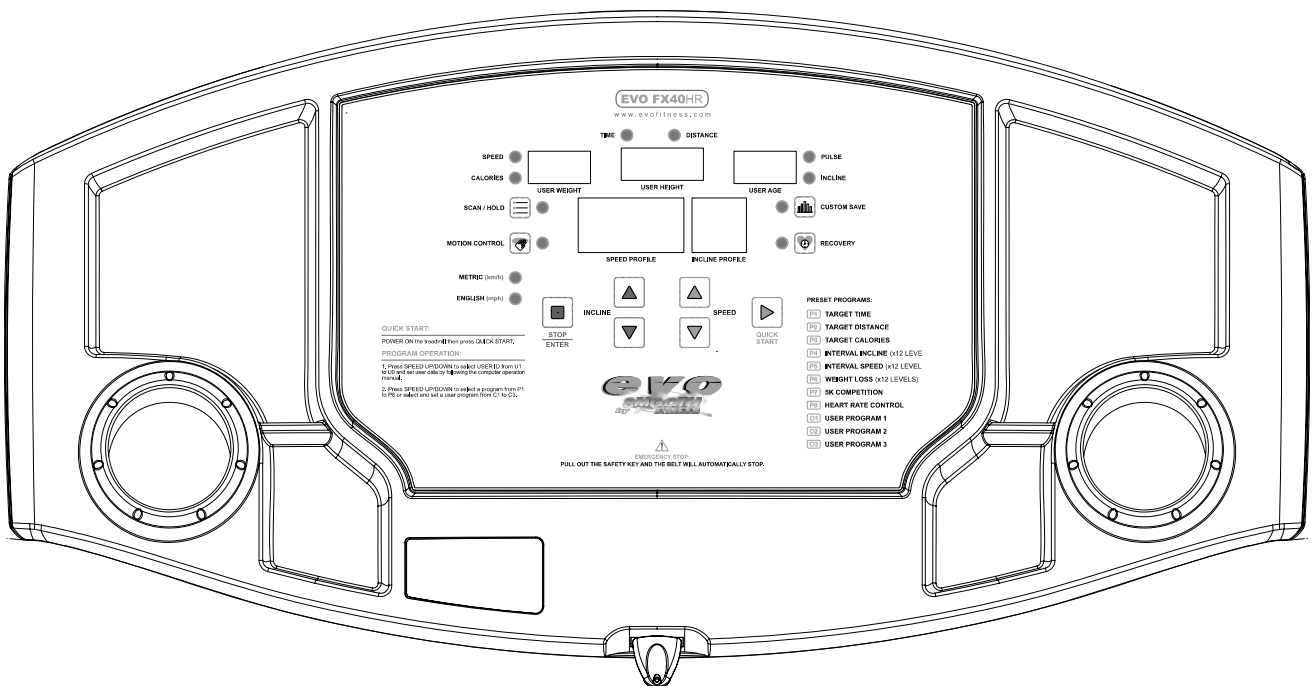

LED 18 COMPUTER INSTRUCTIONS

COMPUTER OPERATION

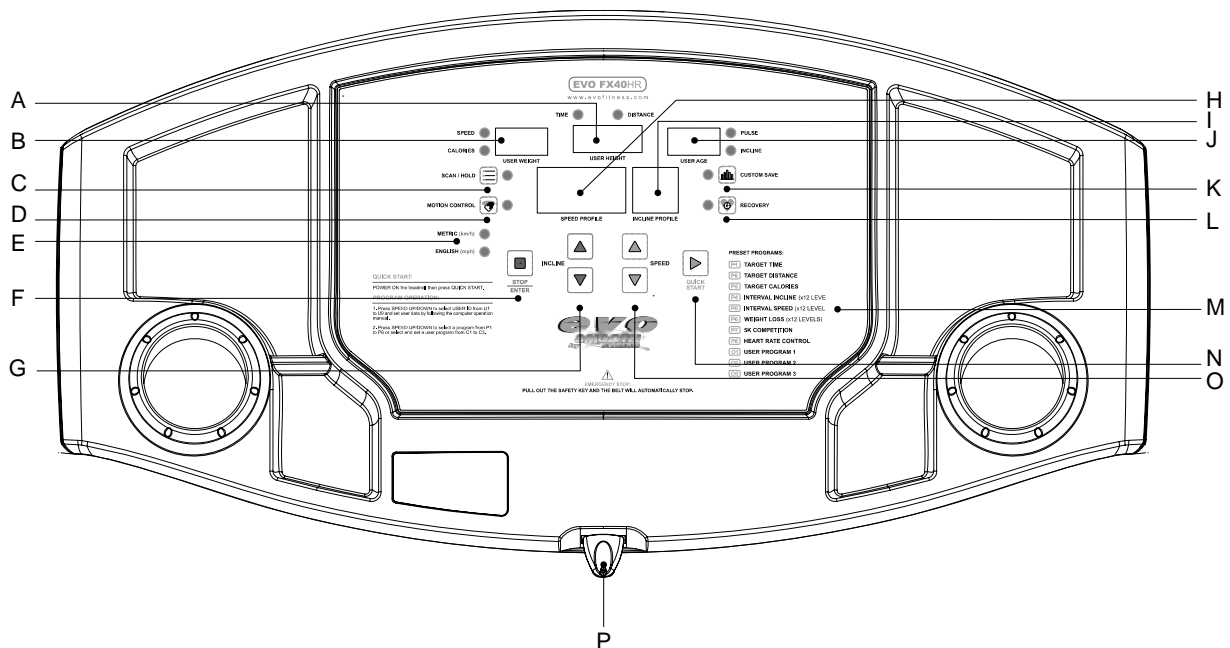

| | | | |
|----------------------|----------|----------|-----------------------|
| Time/Distance/Height | A | B | Speed/Calories/Weight |
| Mode | C | D | Motion Control On/Off |
| Metric/English | E | F | Stop/Enter |
| Incline Up/Down | G | H | Speed Profile |
| Incline Profile | I | K | Pulse/Incline/Age |
| Custom Program Save | K | L | Recovery Program |
| Preset Programs | M | N | Start |
| Speed Up/Down | O | P | Safety Key |

BUTTON FUNCTIONS:**START**

Press to start exercise at an initial speed of 0.5 mph / 0.8 km/h.

STOP / ENTER

- Press to confirm program and preset function values during setting mode.
- Press to run setting procedure before pressing the START button.
- Press to stop exercise during workout time.

Scan/Hold

Switches the LED window display information:

- The computer has a factory setting that auto switches between TIME, SPEED, PULSE, DISTANCE, CALORIES and INCLINE LEVEL. Each value will be displayed for 10 seconds.
- Press the MODE button once to display only TIME, SPEED and PULSE.
- Press the MODE button a 2nd time to display only DISTANCE, CALORIES and INCLINE LEVEL.
- Press the MODE button a 3rd time return to the auto switch display.

MOTION CONTROL

Press to activate the MOTION CONTROL function. Follow the MOTION CONTROL operating instructions for details.

COMPUTER OPERATION

CUSTOM PROGRAM

When selecting the custom program from C1 to C3, follow the instructions to press this button and save the program as your own custom workout program. Follow the C1-C3 CUSTOM PROGRAM operating instructions for details.

RECOVERY

Press to start the RECOVERY function to test your physical condition after a workout. Follow the RECOVERY operating instructions for details.

SPEED UP / DOWN

- Press to increase/decrease exercise speed by 0.1mph / km/h.
- Hold the button to rapidly increase/decrease speed by 0.5mph / km/h per second. Release the button to stop the function.
- Press to select programs and preset related function value.

INCLINE UP / DOWN

- Press up or down to change incline level.

IMPORTANT INFORMATION:

SAFETY KEY

The safety key must be inserted into the slot on the console in order to operate the treadmill. Always insert the safety key and attach the clip to your clothing at your waist before beginning your workout. If you should encounter problems and need to stop the motor quickly, simply pull on the cord to disengage the safety key from the console. To continue operation first turn the power switch to OFF and set the speed controller to stop. Next turn the power switch to ON and reinsert the safety key into the console.

ENGLISH / METRIC CONVERSION

The treadmill computer display can show METRIC and ENGLISH information. This should be preset for your area by the factory. However, in case the treadmill needs to be converted between METRIC and ENGLISH readout, please follow the procedure below:

Set the POWER SWITCH to ON. Press the START button on the computer and hold it. Insert the SAFETY KEY then release the START button. The computer will sound one short beep. Press the START button to switch between ENGLISH and METRIC and press STOP/ENTER button to confirm the setting. The computer will sound a long beep and will return to the POWER ON mode with the new setting.

POWER ON

Set the POWER SWITCH, located on the base frame, to ON and insert the SAFETY KEY. All LED windows light up with a short beep sound. "U1" displays in the LAP window, SPEED/CALORIES displays the user weight factory setting value "150"lbs or "68"kg, TIME/DISTANCE displays the user height factory setting value "67" inches or "170"cm, and PULSE/INCLINE displays the user age factory setting value "35". If there is any user information that has been input and saved, all LED windows will display the information from the last input user information. If no further button inputs are made within 3 minutes, the computer will enter the SLEEP MODE. Press any button to return to the POWER ON mode.

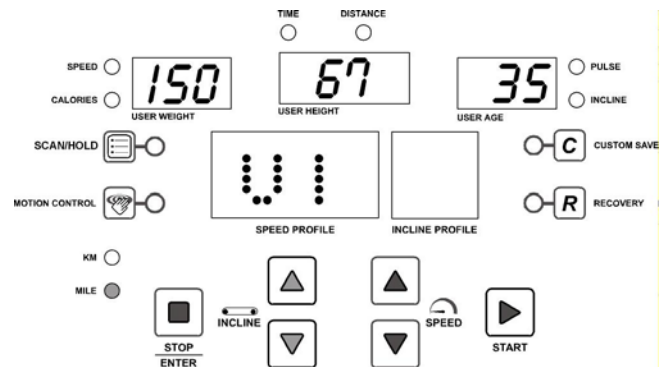

SLEEP / DISPLAY MODE

When the power is ON the computer will automatically enter SLEEP MODE if it is left idle for 3 minutes without receiving any input. Press any button to return to POWER ON status when the computer is in the SLEEP MODE.

To cancel the SLEEP MODE feature using the DISPLAY MODE and always keep the console display on, pull out the safety key, press and hold the SPEED UP and DOWN buttons, insert the safety key to power on the treadmill. After one short beep sound the PULSE LED window will show "1". Press the START button then TIME LED window will show "ON" (SLEEP MODE feature on) or "OFF" (SLEEP MODE feature off). Press the INCLINE UP and DOWN buttons to switch between "ON" and "OFF" then press STOP/ENTER to save the setting and return to POWER ON mode.

COMPUTER OPERATION

OPERATING INSTRUCTIONS:

QUICK START

When the treadmill is in POWER ON status, press the START button to activate the QUICK START program. The SPEED LED will count down 3 seconds with 3 short beep sounds then start from 0.5 mph / 0.8 km/h. Press the SPEED UP/DOWN buttons to change the speed. Press the INCLINE UP/DOWN buttons to elevate the treadmill. The TIME, CALORIES and DISTANCE will count up from 0.

PAUSE / STOP

During the workout press the STOP/ENTER button once to pause the treadmill. Press the STOP/ENTER button twice to delete all workout data and return to POWER ON status.

COOL DOWN

After completion of each program the TIME LED window will show "COOL" and blink then start a one-minute cool down procedure. Time counts down from 01:00 to 00:00 and speed stays at 2 mph / 3.2 km/h and the incline level stays at level 0. After the time counts down to 00:00 the belt stops and returns to PAUSE/STOP status. Press the STOP/ENTER button to return to POWER ON status. To escape the cool down procedure press the STOP/ENTER button once anytime during the process to enter the PAUSE/STOP status and press the STOP/ENTER button again to enter the POWER ON status.

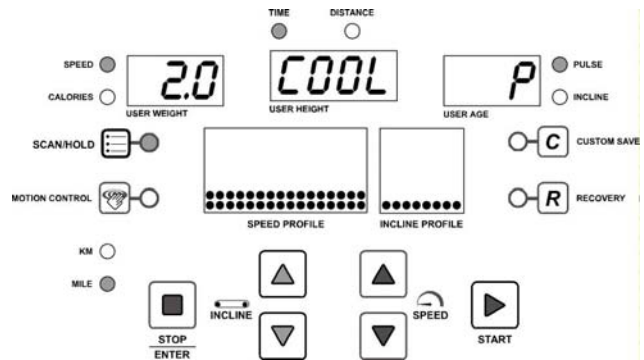

RECOVERY

Recovery is the feature to let the user test their physical condition after a workout. The recovery rating is determined by measuring how quickly the user's pulse slows down after the workout to justify the user physical condition. The faster the pulse slows down, the better the user's physical condition. User's can record their recovery rating after each workout to use for reference. To operate the RECOVERY, press the "R" button after completing a workout. The treadmill will enter the PAUSE/STOP status. Put both hands on the hand pulse sensors within 10 seconds (for models equipped with a chest belt pulse transmitter, keep the chest belt on, no need to hold the hand pulse). The pulse receiver will scan and detect the user's pulse in 10 seconds and enter the RECOVERY procedure. TIME counts down from 01:00 to 00:00. The SPEED LED window will show the RECOVER RATING after the one-minute count down. Record the rating for future comparison.

During the RECOVERY procedure, if you want to stop the RECOVERY and stop workout, press the STOP/ENTER button and return to POWER ON status.

During the RECOVERY procedure, if you want to continue the previous program, press the START button to continue the previous program.

After pressing the RECOVERY button, if the pulse receiver fails to scan and receive the user's pulse the computer will stay at PAUSE/STOP status. Press the STOP/ENTER button to return to POWER ON status or press the START button to continue the previous program.

COMPUTER OPERATION:

Before selecting the program, a user ID needs to be selected. For the first time user, please set up the user information and assign your USER ID from U 1 to U 9. Press the SPEED UP/DOWN buttons to select the user ID when the computer is in POWER ON mode.

SET UP USER INFORMATION

After selecting the USER ID the SPEED LED window will show the previous setting for user body weight or the factory setting value of "150" lbs or "68" kg and be blinking. Press the SPEED UP/DOWN buttons to set the user height then press the STOP/ENTER button to confirm and save.

After setting the user height the TIME LED window will show the previous setting for user height or the factory setting value of "67" inches or "170" cm and be blinking. Press the SPEED UP/DOWN buttons to set the user body weight then press the STOP/ENTER button to confirm and save.

COMPUTER OPERATION

After setting the user weight the PULSE LED window will show the previous setting for user age or the factory setting value of "35" and be blinking. Press the SPEED UP/DWON buttons to set the user age then press the STOP/ENTER button to confirm and save.

SELECT OPERATING PROGRAM

After completing the user information set up the SPEED PROFILE LED window will show "P1". Press the SPEED UP/DOWN buttons to select a P1 – P8 program or C1-C3 user program then press the STOP/ENTER button to confirm. Prior to starting the selected program, follow the procedure to operate the different programs as below:

PROGRAM 1 – TARGET TIME

If P1 is selected, the TIME LED window shows "30:00" as the preset workout time. Press the SPEED UP/DOWN buttons to set target workout time. Press the STOP/ENTER button to save the target time and press the START button to start the program. Speed starts from 2.0 mph / 3.2 km/h. Incline starts from level 0. Press the SPEED UP/DOWN buttons to adjust the speed and press the INCLINE UP/DOWN buttons to adjust the incline level. TIME counts down from the target time to zero.

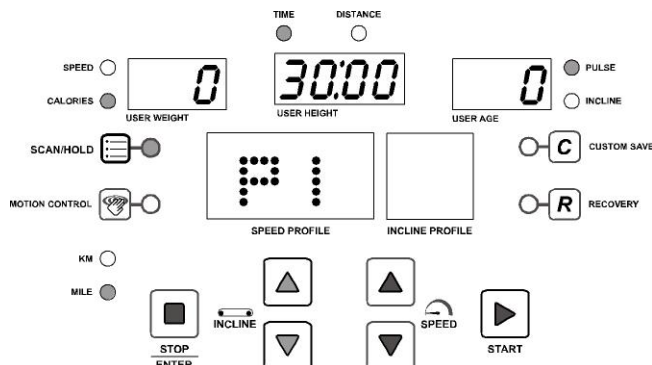

PROGRAM 2 – TARGET DISTANCE

If P2 is selected, the DISTANCE LED window shows "0.00". Press the SPEED UP/DOWN buttons to set the target distance. Press the STOP/ENTER button to save the target distance and press the START button to start the program. Speed starts from 2.0 mph /3.2 km/h. Incline starts from level 0. Press the SPEED UP/DOWN buttons to adjust the speed and press the INCLINE UP/DOWN buttons to adjust the incline level. DISTANCE counts down from the target distance.

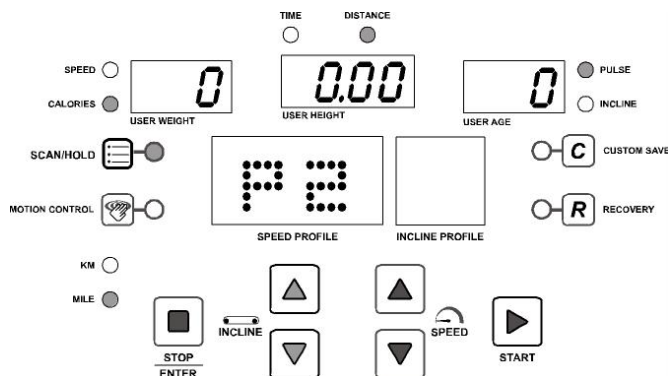

PROGRAM 3 – TARGET CALORIES

If P3 is selected, the CALORIES LED window shows "0". Press the SPEED UP/DOWN buttons to set the target calories. Press the STOP/ENTER button to save the target calories and press the START button to start the program. Speed starts from 2.0 mph /3.2 km/h. Incline starts from level 0. Press the SPEED UP/DOWN buttons to adjust the speed and press the INCLINE UP/DOWN buttons to adjust the incline level. CALORIES count down from the target calories.

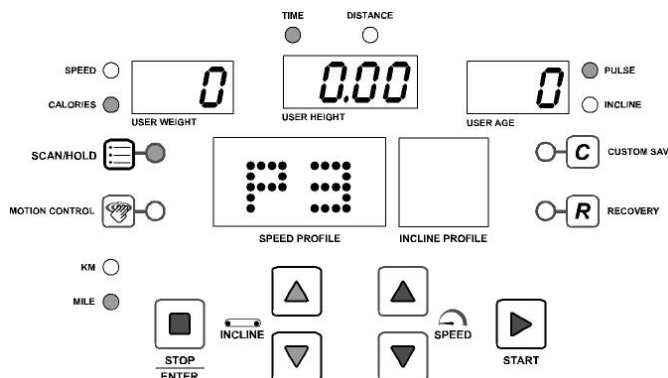

COMPUTER OPERATION

PROGRAM 4 – INTERVAL INCLINE

If P4 is selected, the TIME LED window shows the factory setting value "24:00" and the PULSE/INCLINE LED window shows a blinking "L 1". Press the SPEED UP/DOWN buttons to select the intensity of workout from L1 to L12 then press the STOP/ENTER button. The TME LED window shows a blinking "24:00". Press the SPEED UP/DOWN buttons to adjust the workout time. Every adjustable section is 4 minutes. Press the STOP/ENTER button to save the setting then press the START button to start the program. The incline level will be changed by the computer following the factory setting pattern. Press the SPEED UP/DOWN buttons to adjust the speed.

PROGRAM 5 – INTERVAL SPEED

If P5 is selected, the TIME LED window shows the factory setting value "24:00" and the PULSE/INCLINE LED window shows a blinking "L 1". Press the SPEED UP/DOWN buttons to select the intensity of workout from L1 to L12 then press the STOP/ENTER button. The TME LED window shows a blinking "24:00". Press the SPEED UP/DOWN buttons to adjust the workout time. Every adjustable section is 4 minutes. Press the STOP/ENTER button to save the setting then press the START button to start the program. The speed will be changed by the computer following the factory setting pattern. Press the INCLINE UP/DOWN buttons to adjust the incline level.

PROGRAM 6 – WEIGHT LOST

If P6 is selected, the TIME LED window shows the factory setting value "30:00" and the PULSE/INCLINE LED window shows a blinking "L 1". Press the SPEED UP/DOWN buttons to select the intensity of workout from L1 to L12 then press the STOP/ENTER button. The TME LED window shows a blinking "30:00". Press the SPEED UP/DOWN buttons to adjust the workout time. Every adjustable section is 5 minutes. Press the STOP/ENTER button to save the setting then press the START button to start the program. The speed and incline level will be changed by the computer following the factory setting pattern.

PROGRAM 7 – 5K SELF LEARNING AND COMPETITION

If P7 is selected, the DISTANCE LED window shows "3" miles or "5" km. Press the START button to start the program. Press the SPEED UP/DOWN buttons to adjust the speed and press the INCLINE UP/DOWN buttons to adjust the incline level.

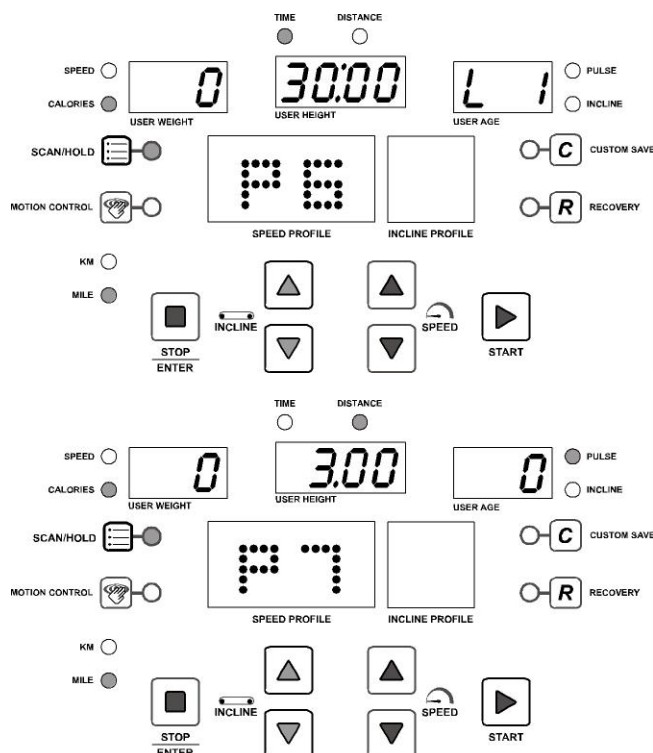
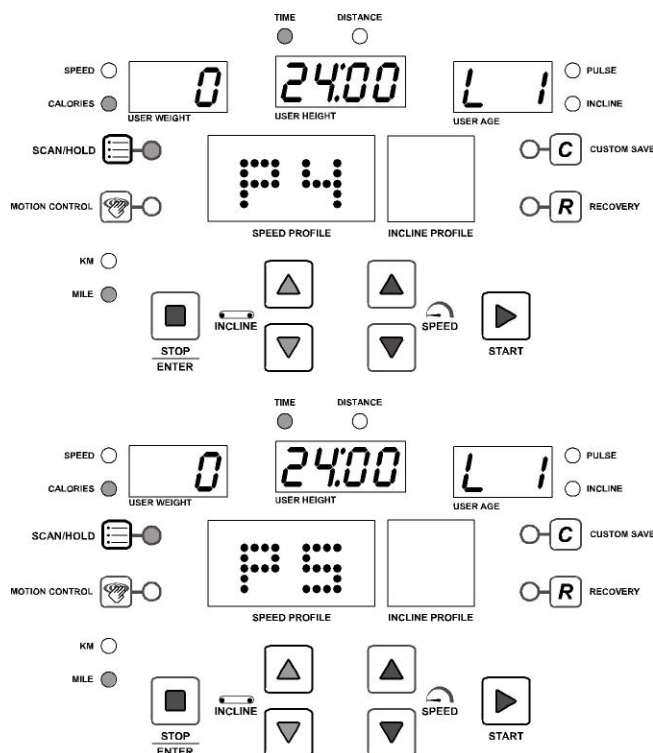

COMPUTER OPERATION

PROGRAM 8 – HEART RATE CONTROL

If P8 is selected, the TIME LED window shows the factory setting value of "60:00" and is blinking. Press the SPEED UP/DOWN buttons to adjust the workout time. Every adjustable section equals 3 minutes. Press the STOP/ENTER button to save the setting then the TARGET HEART RATE displays in the PULSE LED window and is blinking. **The factory TARGET HEART RATE setting is based on 85% of the maximum user heart rate. The maximum user heart rate is calculated using the formula: 220 minus the user age. As an example, for age 35 the maximum user heart rate should be 185 and 85% of the maximum user heart rate will be 157.** Press the SPEED UP/DOWN buttons to adjust the TARGET HEART RATE according to your own physical condition or your doctor's instruction then press the STOP/ENTER buttons to save the setting.

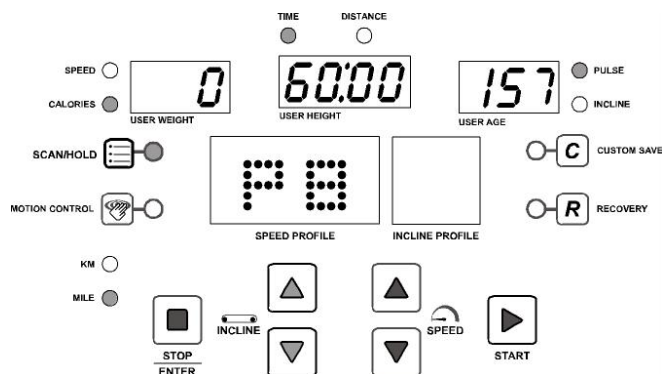

Press the START button to start the three minute WARM UP program. Speed starts from 2.0 mph /3.2 km/h and the INCLINE LEVEL starts from level 0. Keep your hand on the hand pulse grips all the time during this workout in order to monitor your pulse correctly. During the program, if the heart rate monitor fails to sense the user's pulse you will see "P" blinking in the PULSE LED window. If the heart rate monitor senses the pulse properly the PULSE DOT LED blinks and the correct pulse readout shows on the PULSE LED window. The computer will sense the user's pulse every 30 seconds. During the warm up program you can press the STOP/ENTER button to pause or stop the program or press the START button to re-start the program. Other buttons will not react during this warm up process.

During the warm up program, if the heart rate monitor fails to sense the user's pulse (the PULSE LED will display a blinking "P") the computer will not change the speed. If the heart rate monitor senses the user's pulse properly but the actual user's pulse does not reach 65% of the max. heart rate ($(220 - \text{age}) \times 65\%$) then the speed will increase by 0.5 mph /0.8 km/h every 30 seconds. If the actual pulse reaches 65% of the max. heart rate the speed will remain unchanged. If the actual pulse remains at 65% of the max. heart rate for more than one minute the speed will be maintained until the warm up program is finished.

If the actual user's pulse fails to reach 65% of the max. heart rate within the first 3 minutes of the warm up program, the computer will continue a second 3 minute warm up program. All workout information continues to count up and the timer counts down from 3:00. During the second 3 minute warm up the computer will change the incline level instead of the speed. If the heart rate monitor fails to sense the user's pulse (the PULSE LED will display a blinking "P") the computer will not change the incline level. If heart rate monitor senses the user's pulse properly but the actual user's pulse does not reach 65% of the max. heart rate ($(220 - \text{age}) \times 65\%$) then the incline level will be increased by 1 level every 30 seconds. If the actual pulse reaches 65% of the max. heart rate the incline level will remain unchanged. If the actual pulse remains at 65% of the max. heart rate for more than one minute the speed will be maintained until the warm up program is finished.

If the actual user's pulse fails to reach 65% of the max. heart rate within the second 3 minute warm up, the computer will continue a third 3 minute warm up program. All workout information continues to count up and the timer counts down from 3:00. During the third 3 minute warm up both speed and incline remain unchanged regardless the actual pulse. If the time counts down to 0 and 65% of the max. heart rate still cannot be achieved then the TIME LED will show "FAIL" and the program will stop and return to POWER ON status.

After the warm up program is completed, if the actual pulse reaches 65% of the max. heart rate, the computer will enter the HEART RATE CONTROL program. TIME counts down from the previous setting. Distance and Calories continue to count up from the warm up program. During the HEART RATE CONTROL program the heart rate monitor will sense the actual user's pulse every 30 seconds. If the actual user's pulse does not reach 85% of the max. heart rate then the incline level will be increased by 1 level every 30 seconds. If the actual user's pulse reaches 85% of the max. heart rate then the treadmill performance will remain unchanged. If the actual user's pulse is greater than 85% of the max. heart rate, the incline level will be reduced by 1 level. Speed will remain unchanged until the incline level increases up to 15% or down to 0%. If the incline level is up to 15% and 85% of the max. heart rate still cannot be reached then the speed will be increased by 0.5 mph /0.8 km/h every 30 seconds. If the incline level decreases down to 0% and the actual user's pulse is still greater than 85% of the max. heart rate then the speed will be decreased by 0.5 mph /0.8 km/h every 30 seconds.

COMPUTER OPERATION

If the actual user's pulse remains above 85% of the max. heart rate for more than 3 minutes the HEART RATE CONTROL program will shut down and enter a one minute COOL DOWN program.

When the TIME counts down to 0, the HEART RATE CONTROL program is completed and the computer enters a one-minute COOL DOWN program.

After the COOL DOWN program the computer will return to POWER ON status.

The purpose of HEART RATE CONTROL program is to keep the user's pulse between 65% of the max. heart rate and 85% of the max. heart rate to achieve the most efficient workout result.

C1 – C3 CUSTOM PROGRAM (USER PROGRAM)

The program can allow 3 custom programs to be set by users and store the settings for repeated workouts. The maximum workout time of each user program is 60 minutes. During the workout after the TIME counts up to 60:00, the treadmill will start a one-minute cool down procedure automatically. To set and store the user programs, please follow the procedure below:

SET AND SAVE THE USER PROGRAM

Select between C1 to C3 and press the STOP/ENTER button to enter the user program then press the START button. Speed starts at 3.2 km/h / 2.0 mph and the incline level starts at level 0. Each section of SPEED/INCLINE is one minute. Press the SPEED UP/DOWN buttons to change the speed and press the INCLINE UP/DOWN buttons to change the incline during the workout. The computer will take the actual speed and incline level at the last second of each minute section and temporary save as the speed and incline level of that minute section. Continue the workout until you want to stop. Press the STOP/ENTER button to enter the one-minute cool down session. The computer will automatically enter the save program status after the one-minute cool down session. If you want to skip the cool down procedure, press the STOP/ENTER button to enter the save program status.

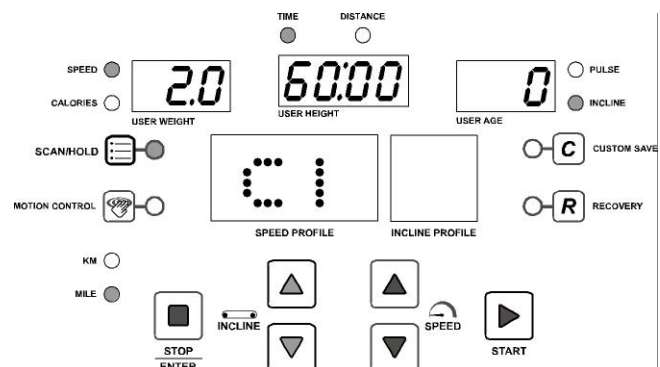

When the computer is in save program status, the "CUSTOM SAVE" button will blink slowly. Press the button to save this program or press the STOP/ENTER button to delete the program and return to POWER ON status.

EDIT PREVIOUS SAVED PROGRAM

Edit the Speed and Incline without extending the previously saved workout time:

Simply press the SPEED UP/DOWN and INCLINE UP/DOWN buttons to change the speed and incline level during the workout then follow the SET AND SAVE procedure after completing the workout.

Extend the workout time from the previously saved program:

If you want to extend the total workout time from the previously saved program press the START button anytime during the workout. The LED of the CUSTOM SAVE button will light up and blink for 10 seconds then stay lit up. After completing the previously saved program the treadmill will start a one-minute cool down session. Press the START button again during the cool down session and the treadmill will skip the cool down procedure and continue running at a speed of 3.2 km/h / 2.0 mph and incline of level 0. Press the SPEED UP/DOWN and INCLINE UP/DOWN buttons for every minute section then follow the SET AND SAVE procedure after completing the workout.

If you already press the START button once during the workout and intend to extend the workout time but decide not to extend the workout time, press the START button again to switch off the LED light of CUSTOM SAVE button. Or wait till the previous saved program complete and complete the cool down procedure then follow the SET AND SAVE procedure.

COMPUTER OPERATION**USING THE CHEST BELT HEART RATE MONITOR (optional feature dependant on model purchased):**

For proper operation, the chest belt should be worn across the front of your body just below the chest line as shown in the drawing. To ensure a proper operation the chest belt needs to be moisturized, please make the 2 rubber pads under the chest belt wet prior to exercising.

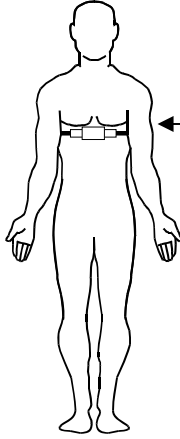

Strap chest belt across the front below the chest line.

MOTION CONTROL OPERATION

MOTION CONTROL:

Walking belt speed can be increased, decreased or stopped using the Motion Control sensors on the handlebars. To do this follow the instructions below:

NOTE: Photos may differ slightly from your treadmill.

1. Press the  MOTION CONTROL button on the console to switch the motion control function on and off:
 - When the LED light is **ON** the MOTION CONTROL is **active**.
 - When the LED light is **OFF** the MOTION CONTROL is **off**.

2. After switching on the MOTION CONTROL wave your right hand approximately 6 inches above the motion sensor on the right handle bar to increase the speed. The sensor will sound one short BEEP per scan and speed up by 0.1 MPH per BEEP. Holding your right hand approximately 6 inches above the right sensor constantly results in the sensor sounding one long BEEP per second and speeding up by 0.5 MPH per second.

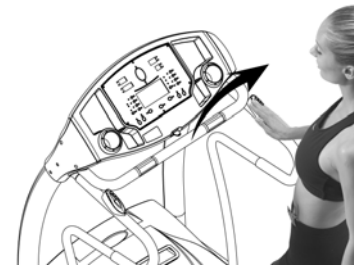

2. Use right sensor to speed up.

3. Wave your left hand approximately 6 inches above the motion sensor on the left handle bar to decrease the speed. The sensor will sound one short BEEP per scan and decrease speed by 0.1 MPH. Holding your left hand approximately 6 inches above the left sensor constantly results in the sensor sounding one long BEEP per second and decreasing speed by 0.5 MPH per second.



3. Use left sensor to slow down.

4. Wave both hands approximately 6 inches above both motion sensors at the same time. The sensor will sound two short BEEP sounds then stop the belt.
 - **Always switch off the motion control function by pressing the  MOTION CONTROL button on the console before turning off the power to the treadmill.**

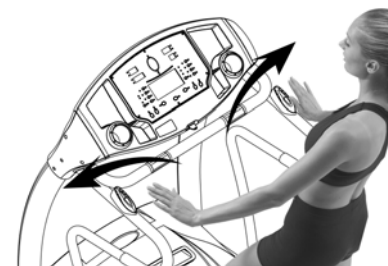

4. Use both sensors to stop belt.